



## CATHEDRAL OF PORTO, PORTUGAL: CONSERVATION WORKS 2003-2008

**P.B. Lourenco<sup>1</sup>, L.F. Ramos<sup>2</sup> and K.J. Krakowiak<sup>3</sup>**

<sup>1</sup> Professor, ISISE, Department of Civil Engineering, School of Engineering, University of Minho, Azurém, 4800-058 Guimarães, Portugal, pbl@civil.uminho.pt

<sup>2</sup> Assistant Professor, ISISE, Department of Civil Engineering, School of Engineering, University of Minho, Azurém, 4800-058 Guimarães, Portugal, ramos@civil.uminho.pt

<sup>3</sup> PhD student, ISISE, Department of Civil Engineering, School of Engineering, University of Minho, Azurém, 4800-058 Guimarães, Portugal, konrad@civil.uminho.pt

### ABSTRACT

This paper presents selected works carried out at the Cathedral of Porto, Portugal, as a case study that challenges current recommendations for the conservation and restoration of architectural heritage. The historical information is briefly reviewed and the general conservation approach for the different works is addressed. Afterwards, the aspects regarding the strengthening of the towers, diagnosis of a chapel, strengthening of the transept and diagnosis of the main façade are addressed.

**KEYWORDS:** heritage buildings, inspection/diagnosis, strengthening, NDT, structural analysis.

### INTRODUCTION

The foundation of the Cathedral of Porto is the middle of the 12<sup>th</sup> century. In this period it is possible to witness the construction of cathedrals in the main cities across Europe, as a token of a renewed confidence in urban communities. For 800 years, the settlement was a repository of added parts. In a framework of a continuous construction yard, the main fabrics are: Romanesque and proto-gothic, gothic, renaissance, mannerist, baroque, neoclassic, contemporary works from the first half of the 20<sup>th</sup> century and, finally, the present works. The governing thread of the program of the current intervention is to rehabilitate the previous restoration works, carried out in the first half of the 20<sup>th</sup> century, see [1] for details on the evolution of the complex and the basis for the conservations works carried out. The aim is to reactivate, rehabilitate and up-grade the competence, where competence is understood as the capacity to perform adequately, of the structures, the materials, the shapes and also the space, assumed as a support for functionality. The intervention in the building was organized around five operations: removal of infestations, consolidation, water-tightness, ventilation and protection.

Figure 1 shows selected views of the compound of the Cathedral, which has dimensions about 60 × 60 m<sup>2</sup> in plan, with a maximum height of the towers about 35 m. The compound includes the church, a gothic cloister on the south side, side chapels, a gallery on the north side, a sacristy,

several chapels and other annexes. The church has a typical Latin cross, with three naves and five spans, and two rectangular towers facing west.

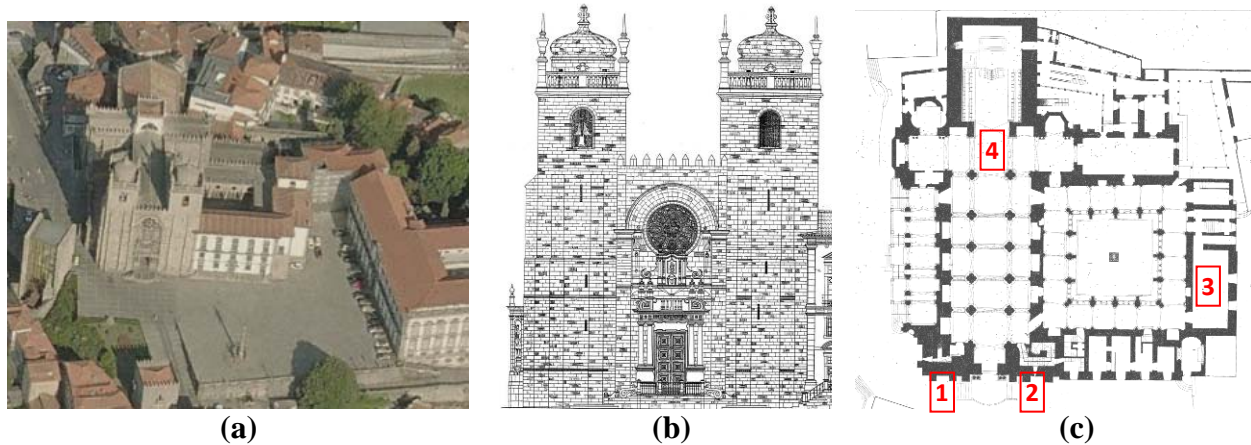

**Figure 1: Aspect of the Cathedral: (a) Aerial View; (b) Façade; (c) Plan.**  
**Legend: 1 – North Tower; 2 – South Tower; 3 – St. Vincent Chapel; 4 - Skylight**

### OVERVIEW OF THE CONSERVATION WORKS

The restoration carried out in the first half of the 20<sup>th</sup> century used traditional construction techniques. Some of the structural deficiencies encountered were then solved with the dismantling and rebuilding of unstable parts, and with the replacement of deteriorated or damaged granite, with poor mechanical performance. The sole concession to the industrial technology is the use of Portland cement, used as a common binder for repointing masonry joints, rendering walls and several reparations that during and after the restoration works, aimed at solving the following issues, without success: waterproofing of surfaces, glue and reconstitute volumes, stabilize cracks and stop movements. It is precisely with respect to these issues that deeper interventions have currently been carried out, some without visible effects and other with the addition of parts, as in the strengthening of the towers. Figure 2 to Figure 5 details some of the aspects of the works carried out. Diagnosis and strengthening of the towers, the St. Vincent Chapel, the skylight in the transept and the salient elements in the main façade are addressed next, in separate sections. Additional aspects of the works carried out are addressed in [1].



**Figure 2: Works in Roof Structures Included Cleaning, Application of Biocide, Application of Preservation Products, Consolidation, Strengthening and Local Replacement. Other Experts Were Responsible for Diagnosis and Specific Treatments.**



**Figure 3: Replacement of the Ceramic Tiles Including New Anchors, Traditional Eaves, Strengthening in the Corners, and Introduction of Sheeting and Walkways.**

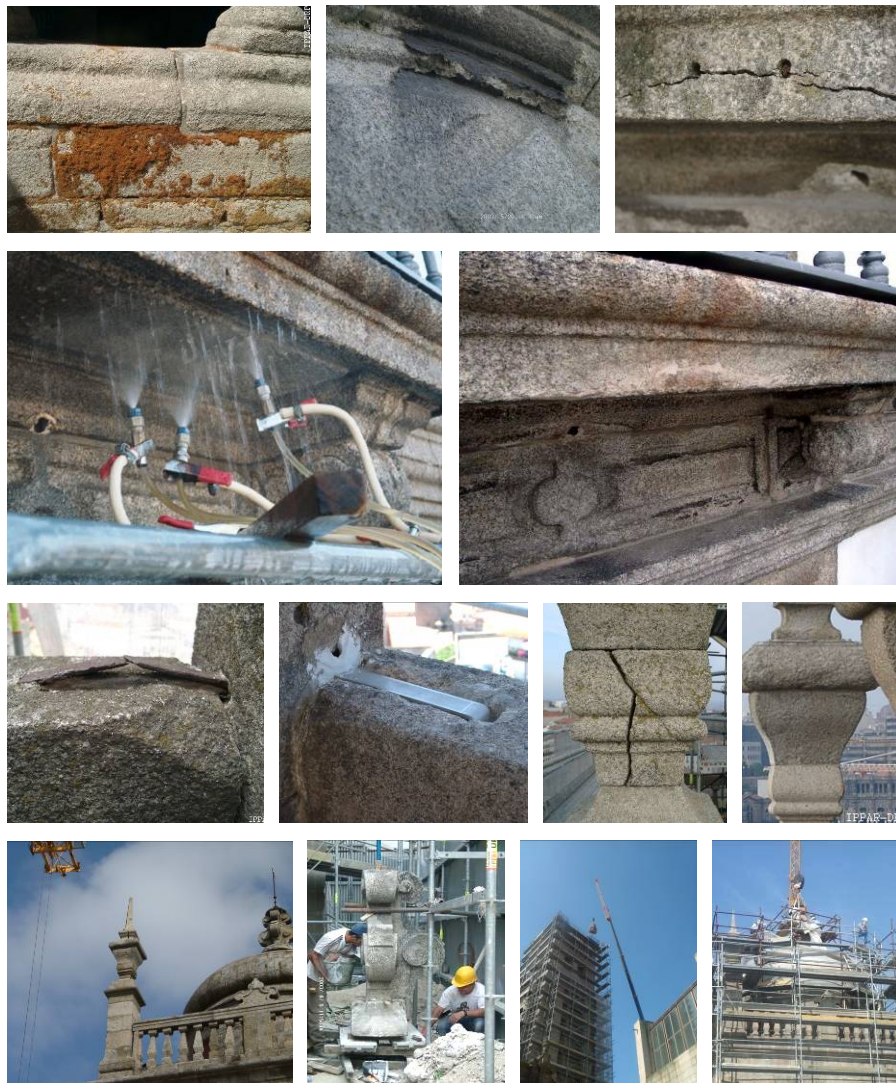

**Figure 4: Remedial Measures for Stone, Including Removal of Biological Activity, Dry and Low Pressure Water Cleaning, Localised Consolidation, Application of Water Repellents, Reconstitution of Voids, Crack Closure and Injection, Replacement of Iron Cramps, and, Exceptionally, Replacement of Stone Pieces. Other Experts Were Responsible for Diagnosis and Specific Treatments.**



**Figure 5: Keeping the Water Out, with Protection of the Granite Stone by Copper Sheeting in External Horizontal Planes and Repointing Joints with Lime Mortar.**

### REMEDIAL MEASURES IN THE TOWERS

The main façade was built in 1176-1200 (central part) and 1229-1325 (towers). The towers evolved into a Bell-tower (North) and a Clock-tower (South). In 1552, damage due to lightning is reported in the South tower. In 1665-1669 the South tower was demolished up to mid-height and rebuilt. In 1717, it is recorded that the South tower was in the verge of collapse and, in 1727, buttresses were added, similarly to the ones that already existed in the North tower. Pinnacles were added in 1732. The construction of the Chapter House, contiguous to the South tower, also aimed at consolidating the tower. Also in this period, the two small windows in the main façade (South tower) were replaced by a single large window, similar to the one that existed in the North tower. Before 1841, a new lightning hit the South tower.

The cross section of the towers is approximately square with a side of 10.0 m and exhibits a variable thickness, with a minimum of 1.7 m at the base. The height of the towers is approximately 35 m, which means that the average stress at the base is around  $1.0 \text{ N/mm}^2$ . This value is rather low for regular granite masonry but it is rather high for rubble masonry (with or without mortar joints). In the main façade, two buttresses are apparent in each tower, see Figure 1b. As addressed above, the structure suffered several major modifications through time, which resulted in a very complex internal structure with different load bearing internal elements at each level. The structure of the towers cannot be understood from structural reasons and several openings are closed, facing staircases or vaults. The entrance for both towers is located at mid-height, with a connection between both towers from the top of the main vault. But the two towers have a rather different structure. The North tower (presently with the bells and clock) features a horizontal mid-level with stone slabs and architraves apparently supported in columns and stone struts, see Figure 6a. The South tower possesses an internal core with a staircase shaped helicoidally, see Figure 6b,c.

The constitution of the masonry walls from the towers was characterized using visual inspection, both by removing stones of the outer leave in the interior of the tower and by using a boroscopic camera inserted in cracks or in holes drilled in joints, see Figure 7a. From the inspection, it was possible to conclude that the three-leaf walls have external leaves of granite ashlar with a thickness ranging from 0.30 to 0.70 m, while the middle leave is made from loose smaller stones and / or silty soil, see Figure 7b and Figure 8. The combination of heavy rain in Porto, strong winds in the top of the hill where the Cathedral is located, and the open joints in the external masonry face, results in a wet infill even in the summer and the continuous washing out of the infill.

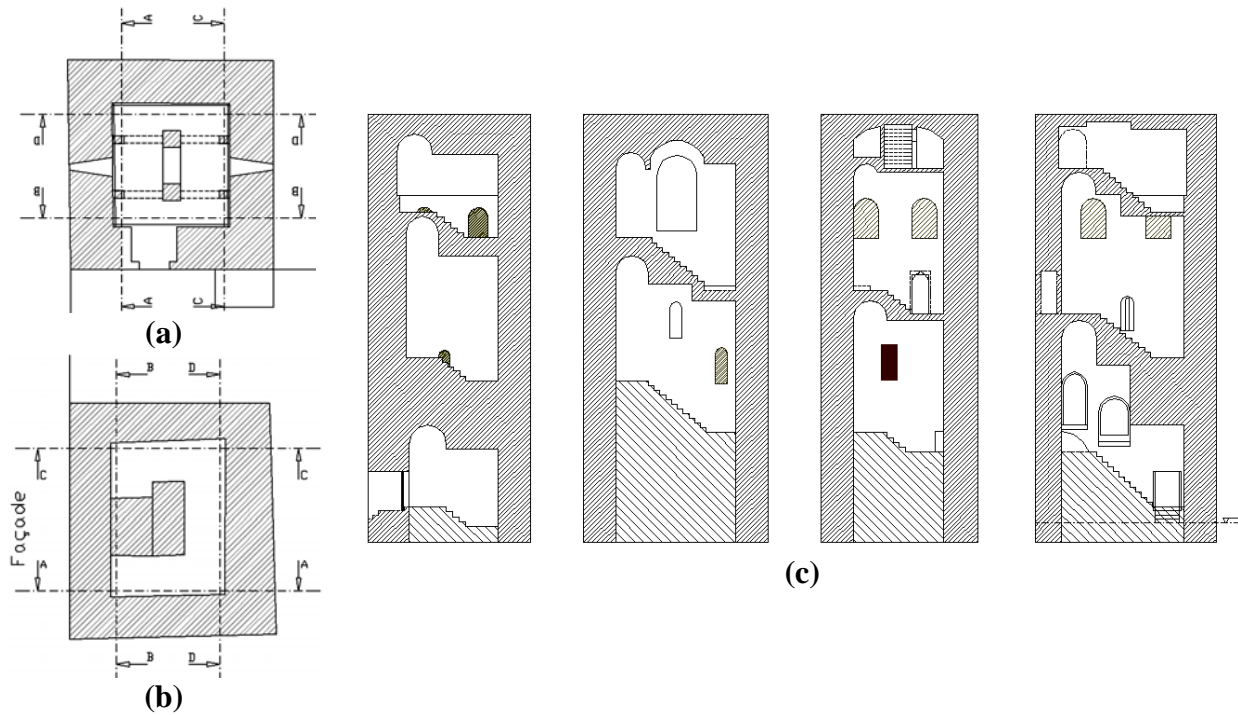

**Figure 6: Partial Sections of the Towers: (a) Horizontal Section of the South Tower, (b) Horizontal Section of the North Tower; (c) Sections A-D for the South Tower.**

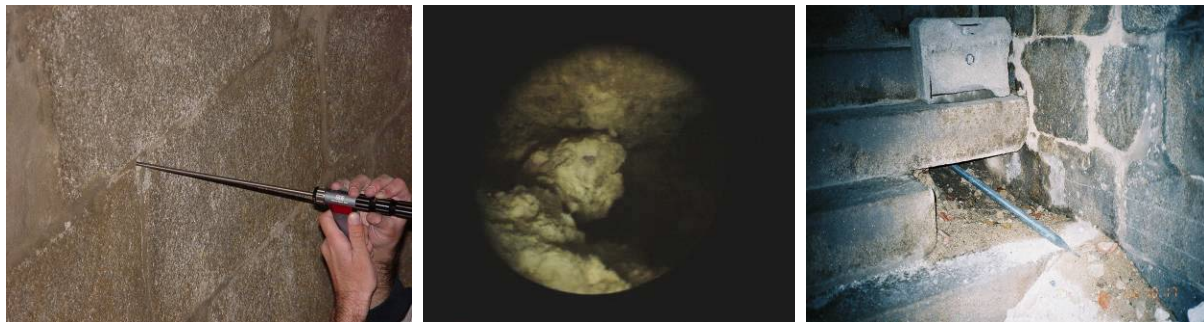

**(a)**



**(b)**

**Figure 7: Visual Inspection to Define the Constitution of Masonry Walls: (a) Boroscopic Camera and Inspection Openings; (c) Loss of Material Through Cracks in the Middle Plane of Walls Through Existing Openings.**

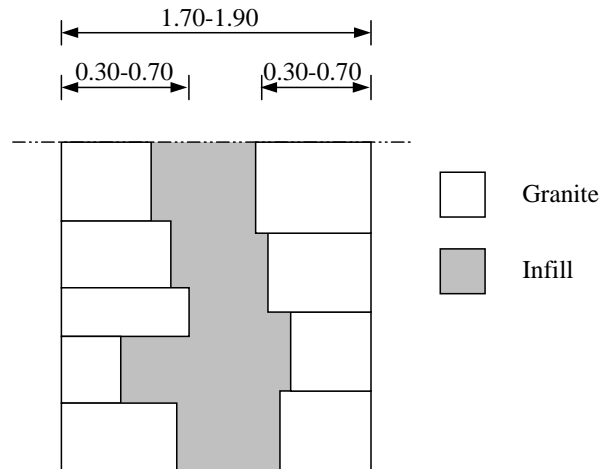

**Figure 8: Typical Cross Section of the Masonry Walls.**

The towers exhibit distributed cracking and significant out-of-plane movements. The existing damage resulted in the past addition of three iron ties (date unknown), see Figure 9a. Tie  $T_1$  presents a severely deformed anchorage and tie  $T_3$  is corroded and broken, see Figure 9b. It is stressed that the separation between the East and West façades of the South tower continued after tie  $T_3$  was broken. It is also noted that the masonry walls in the vicinity of the anchorages are also deformed, as expected due to the application of a large point load.

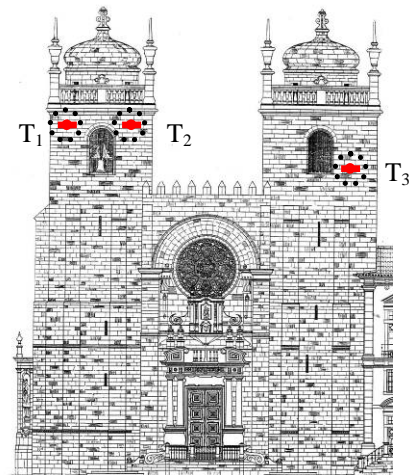

**(a)**



**(b)**

**Figure 9: Ancient Tower Ties: (a) Deformed Anchorage ( $T_1$ ); (b) Details of Broken Tie ( $T_3$ ).**

The South tower is more damaged than the North tower. Figure 10 exhibits the location of severe cracks and out-of-plumb walls in the South tower. Also the East façade of the South tower presents out-of-plane movements to the exterior. It is noted that the internal walls of this tower are straight, indicating crumbling or desegregation of the walls, with major cracks and voids in the interior. The separation between the internal and external leaves of the walls is further confirmed by the longitudinal cracking observed in most of the openings. Figure 10c illustrates such cracking, with a maximum width of some centimeters. Finally, it is noted that the North tower presents severe distributed vertical cracking at the base. This cracking is only visible in the internal (medieval) face, while the external face seems undamaged. Moreover, the very large thickness of the walls is not replicated in the South tower. For these reasons, it is believed that the damage is not recent and the helicoidal staircase belongs to the structure of an older tower. Finally, the misconception of the structure supporting the bells and clock in the North tower is also noted, see Figure 11.

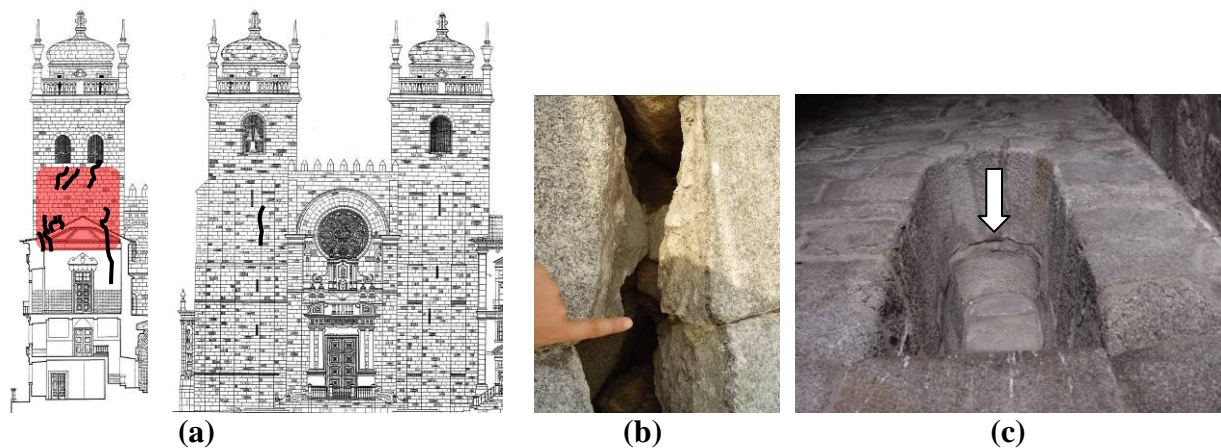

**Figure 10: Cracks up to 0.20 m Width: (a) Location of Severe Cracks and Out-of-Plumb Walls, in the South View and Main Façade; (b) View of External cracks and Typical Active Cracks Parallel to the Walls at the Openings.**



**Figure 11: Deficient Structural System to Support the Bell Stone Level Floor.**

As it arises from the history and survey, the towers seem to have been damaged in the past and rebuilt (particularly the South tower). The (re)construction seems to have been carried out under deficient execution conditions, no particular well defined structure and using improvised construction details. In addition, different remedial techniques were already used in the past aiming at correcting and strengthening the towers. The walls of the towers seem not to possess

adequate connection between the external leaves and severe water infiltration in the walls contributed to the existing damage and to the loss of material in the rubble infill. Here it is again stressed that the Cathedral is located at the top of a hill, the external masonry joints have lost all mortar and it was found that the rubble infill was wet by the end of the summer. Besides other damage, the most relevant feature is that the North tower is divided in two similar channel-shaped parts, from mid-height to the top, with full cracks along the West-East direction (in the other direction, the existing ties kept the tower together), and the South tower is bulging outwards both to South and to East (the existing West-East tie is broken).

The solution adopted for strengthening consists mostly of a steel ring in both towers, aiming at confining the structure along the two orthogonal directions, in the sole location possible, see Figure 12a,b. The rings are made with welded stainless steel plates (class AISI 316L), connected to the towers using long, inclined stainless steel anchorages inside of a cloth duct to prevent generalized injection, see Figure 12c-e. The length of the steel profiles is defined so that the elements can be transported to the location through the existing doors and can be easily assembled in situ, without any further welding. In the North tower, the ring also aims at providing a support for the stone pavement for the bells. The reason being that the stone columns are much deteriorated and possess presently no structural function and the stone struts have very deficient conception, see Figure 11. Here it is noted that it was decided not to recuperate the structural function of the columns (e.g. using injection) because the lower level seems to indicate insufficient strength of the inner core. The steel ring is made of channel profiles ( $240 \times 120$  mm and  $200 \times 100$  mm height). In the South tower, a set of two ties was provided to the ring, because it was possible for aesthetic reasons and they are a witness of the ancient broken tie. The ring must cross the staircase at a selected location because the complex internal structure of the tower does not allow otherwise. Due to the lack of internal stiffening elements, a much stiffer steel frame is needed and the steel ring is made of H profiles ( $180 \times 180$  mm). Due to the bulging outwards of the East and South façades, and the severe cracks in the corners, several short ties have been added to the structure to stitch the East and South façades, and two long ties through the core of the South façade have been added to connect the West and East façades, see Figure 12f. Figure 12g presents details of the two types of anchorage plates adopted (circular plates and specially designed crosses).

The other works carried out included repairing the pinnacles (the North tower pinnacle was jacketed with steel plates at the top and bottom necks) and balustrades (replacement of iron dowels and ties by stainless steel), injection of the main cracks with lime based grout, repointing all joints with two selected lime mortars (a traditional mortar for the filling and a more durable lime mortar for the finishing), protection against corrosion (the two ties in the North tower were kept in place) or replacing all existing iron.



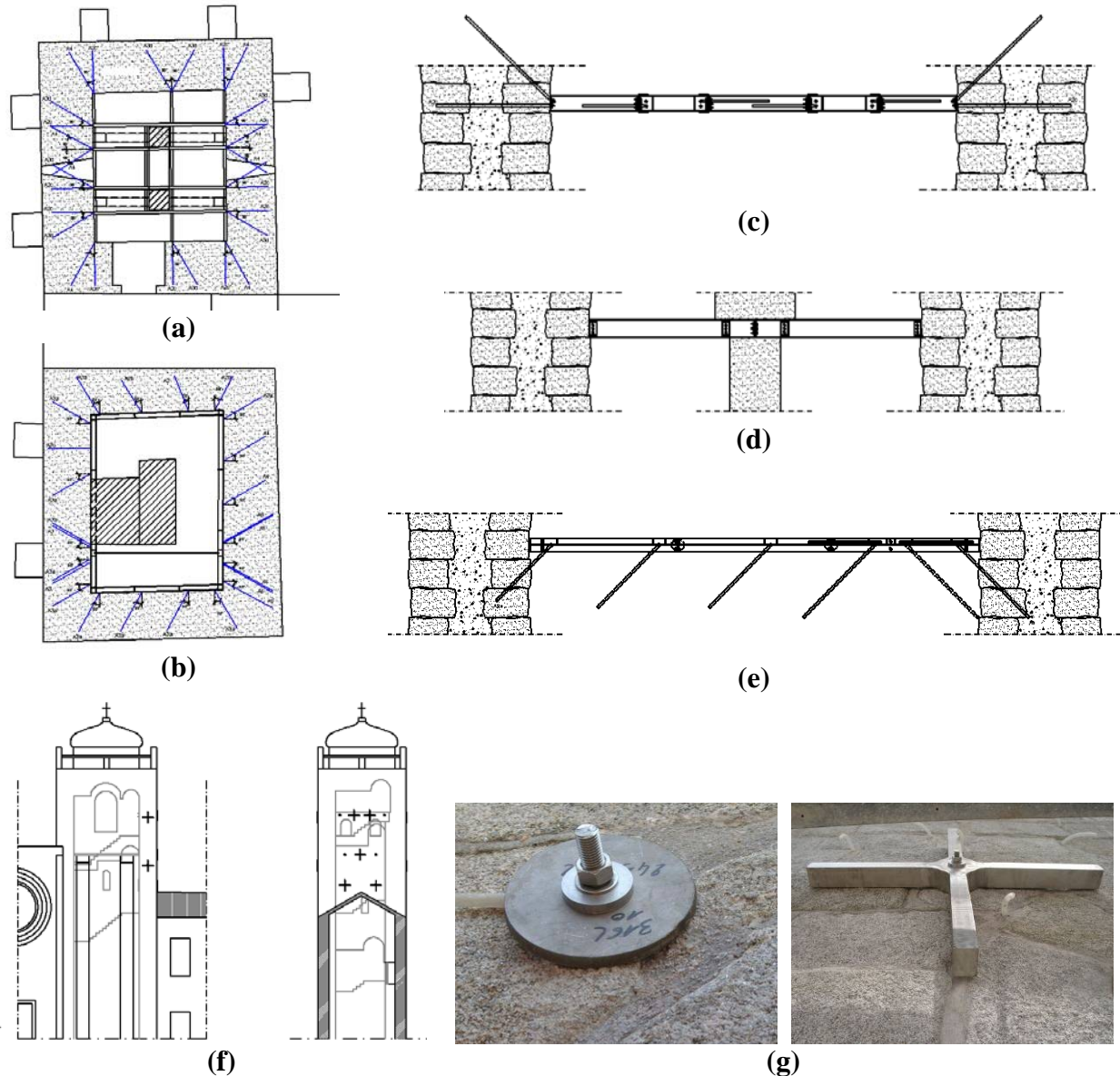

**Figure 12: Aspect of the Strengthening of the Towers Using Stainless Steel Rings and Long Inclined Anchorages: (a) Plan of the Ring for the North Tower; (b) Plan of the Ring for the South Tower; (c) North-South Section for North Tower; (d) West-East Section for North Tower; (e) Typical Section for South Tower; (f) Additional Ties Placed in the West and South Façades of the South Tower; (g) Details of the Anchorage Plates.**

Given the cultural importance of the building and the significant damage in the South tower, a monitoring system was planned and installed. The system includes four waterproof crackmeters in the largest cracks, two strain gages for the new ties, two biaxial clinometers to measure the tilting of the tower, as well as temperature, humidity and wind sensors. The system includes also a GSM interface for remote monitoring, see Figure 13a,b. Here, F1 to F4 indicate crackmeters, E1 and E2 are vibrating wire extensometers, TS1 and TS2 are temperature sensors, TH is a combined temperature and relative humidity sensor, C1 and C2 are tiltmeters and V is an anemometer capable of measuring wind direction and velocity.

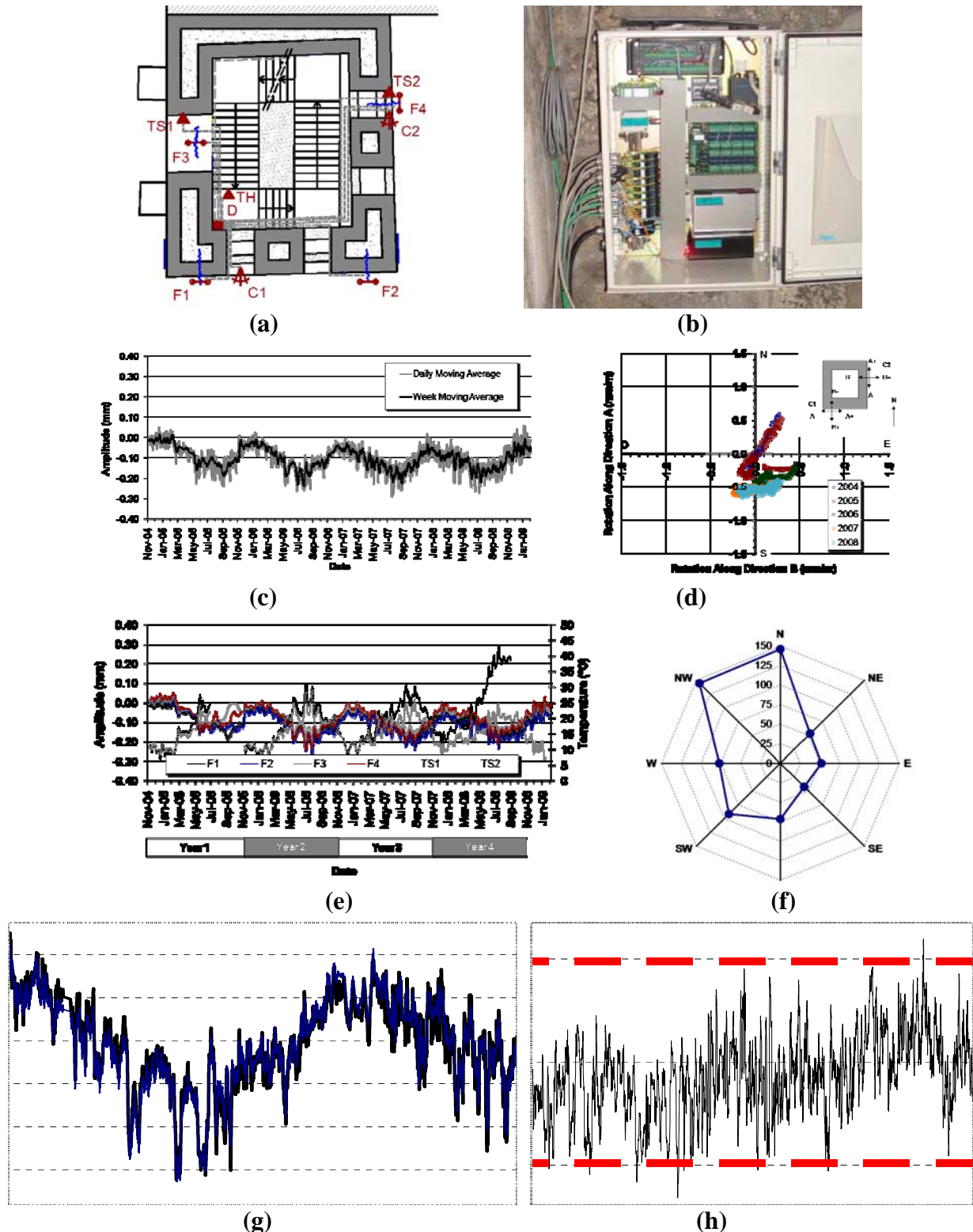

Figure 13: Monitoring system: (a) Applied sensors; (b) Datalogger; (c) Typical Crackmeter Results; (d) Typical Tiltmeter Results; (e) Week Average of Crackmeters vs. Temperature; (f) Maximum Wind Speed in Anemometer; (g) Typical Crackmeter Results Measured (Black) vs. ARX Model (Blue); (h) Typical 95% Confidence Interval in Crackmeter.

The measurements in the crackmeters (amplitudes lower than 0.3 mm) and clinometers (amplitudes lower than 0.6 mm/m) are rather small and they follow the temperature measurements, see Figure 13c,d,e. The wind speed measured indicates that the direction of the gust wind is North / Northwest, with velocities up to 150 km/h, see Figure 13f. An autoregressive exogenous (ARX) model [2] indicates that the measurements of the cracks are of good quality and the variations are explained by the environmental effects and not by crack opening, see Figure 13g,h. A similar conclusion holds for the measurements of stresses in the steel ties. The values in the tiltmeters are low but a rotation seems to be observed in the South tower, around 0.01°/year or 0.1°/decade, see also [3].

### ST. VINCENT CHAPEL

The Saint Vincent Chapel is located next to the South wing of the Cathedral cloister. During the restoration works of the roof, it was found that the extrados of the chapel vault was filled with rubble resulting from old demolitions see Figure 14. Also, and as usual in several historical constructions, the timber roof was partly supported by the vault, using later added struts. The issue addressed here is the stability of the vault and the convenience of the removal of the infill.

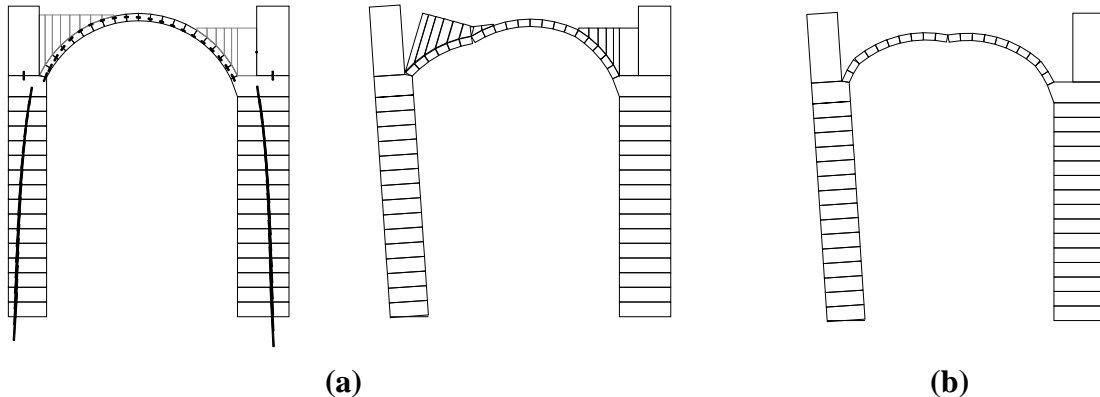

**Figure 14: Roof of Saint Vincent Chapel: (a) Aspect of Restoration Works; (b) Aspect of Vault Infill with Rubble.**

The structure consists of a barrel vault with an approximate thickness of 0.25 m and a span of 6.8 m. On the North side, the cloister acts as a buttress but on the South side no buttresses are present. Even if the South wall (1.70 m) is thicker than the North wall (1.30 m), out-of-plumb movements outwards are clearly visible in the former, up to 1.5% (or 0.10 m at the springer of the vault). Nevertheless, as the vault presents only minor cracking, it was believed that the vault was built after the wall deformation.

A plane model was adopted for the structural analysis of the barrel vault. The analysis was carried out using limit analysis, discretizing the walls and vault as a set of rigid blocks [4]. The assumed material properties include a tensile strength equal to zero, a tangent of the friction angle equal to 0.7, zero dilatancy and a compressive strength equal to 6 N/mm<sup>2</sup>. The actions included consist only of the self-weight of the structure. As the objective of the analysis is to evaluate the influence of the infill, a sophisticated representation of the structure is not particularly relevant. Therefore, the influence of the cloister, openings of the walls and ribs of the vault were neglected in order to avoid the need of a three-dimensional model.

The numerical results are given in Figure 15, in terms of thrust-lines and collapse mechanisms, for the model with and without infill. The ultimate load factor increases 45% if the infill is removed, which seems also natural because it was not originally planned for this construction.



**Figure 15: Results of the Numerical Analysis, in Terms of Thrust-lines and Failure Mechanisms: (a) With Infill, for an Ultimate Load Factor Equal to 6.5; (b) Without Infill, for an Ultimate Load Factor Equal to 9.4.**

The infill was removed but, for safety reasons, it was recommended to accompany this task with topographic measurements, see Figure 16a. The targets were read always at early morning to reduce temperature effects, daily during the process of infill removal (one week) and weekly during one month after load removal. Approximately 35 m<sup>3</sup> (7000 kg) of rubble were removed from the vault and no movements were recorded in the targets. Figure 16b demonstrates that the vault was never conceived to accommodate infill, and a timber roof existed at the level of the vault, before the construction of the vault and the new roof at a higher level.



**Figure 16: Infill Removal: (a) Location of Topographic Targets for Monitoring; (b) Aspect of the Cleaned Vault.**

### SKYLIGHT IN THE TRANSEPT

The skylight is located above the transept and presents different cracks, which occurred after the works carried out in the first half of the 20<sup>th</sup> century. In addition, infill material from the vault had recently fallen in the transept. The skylight is made of four walls supported in large arched windows opened in the 18<sup>th</sup> century, with the exception of the East façade with exhibits no opening, see Figure 17.

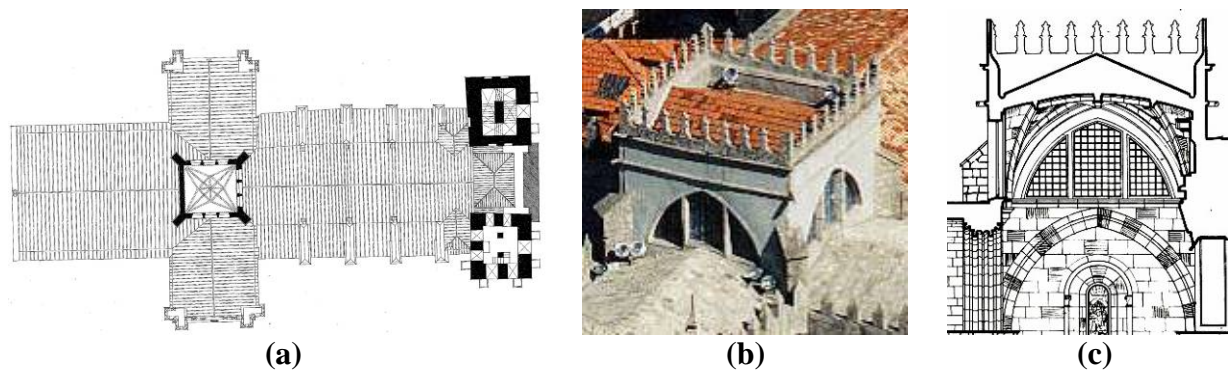

**Figure 17: Views of the Transept: (a) Plan; (b) Aerial View; (c) Cross Section.**

The skylight has a square plan with 7.5 m side, walls with 6.5 height and 0.65 m thickness. The thickness is reduced to 0.4 m above the vaults and, again, to 0.2 m in the battlements. Buttresses can be found in each corner and a ribbed stone vault makes the ceiling, further topped by a timber double slope roof. The masonry in the walls is of very low quality, made of rubble stone and weak lime mortar. The openings form pointed arches, supported at the thirds of the span with T-shaped columns. The vault is made with stone slabs with a thickness between 0.14 and 0.54 m. Rubble loose infill was removed on top of the vault (about 10 m<sup>3</sup>).

The three walls with windows are cracked at the arch key, with maximum crack widths of 10, 1 and <0.5 mm, in the façades West, North and South, respectively. These walls are also bulging outwards. Figure 18a shows the main crack in the West façade, which crosses the entire section of the wall. Smaller cracks can be also observed closer to the buttresses, under the opening. Figure 18b shows a typical detail of the columns with a horizontal crack due to bending. But the most severe crack in the interior has a width of 25 mm and shows that the vault is separated from the wall in the West façade, see Figure 18c. Due to this crack, the stone slabs of the vault are no longer supported in the side rib and a settlement of about 20 mm can be observed at the key of the vault.

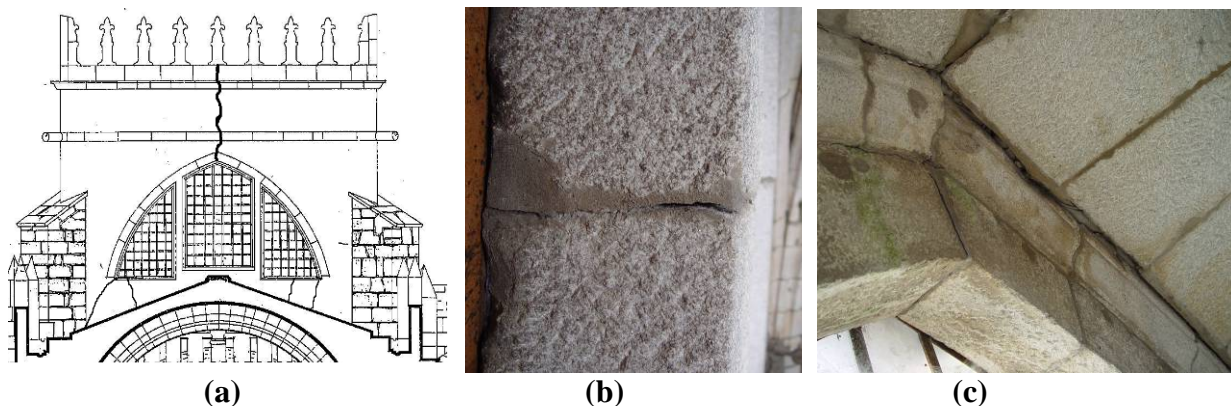

**Figure 18: Examples of Cracks in the Skylight: (a) Exterior, Above the Arch; (b) Interior, Bending of Column; (c) Interior, Separation of Wall and Vault.**

There are many other cracks in the arches and columns of the opening. These cracks are due to the presence of the columns, possibly with the function to support the framing of the windows, which destroy the arching action. The cracks in the exterior are not in correspondence with the interior, due to the out-of-plane flexure of the walls. The façades South and East exhibited minor damage in the inside.

The observation of the damage in the skylight, together with the local relief, the severe separation between the East façade and the chancel, the old documents indicating consolidation and enlargement of foundations and the bulging of the walls of the nave indicate that soil settlements and weak foundations can be the main cause of damage, see also Figure 19.

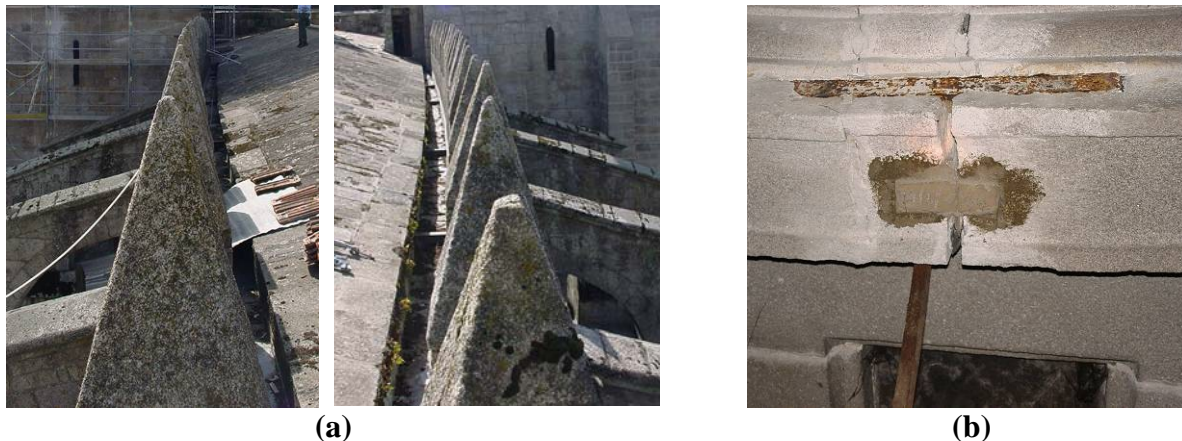

**Figure 19: Observed Damage in the Vicinity of the Skylight: (a) Bulging of the Walls of the Nave; (b) Cracking Between the Chancel Vault and the East Wall.**

The finite element method was used to understand and justify the existing damage. Initially, a 3D model of the skylight was prepared using volume elements, to represent the walls, buttresses, columns and ribs, and shell elements, to represent the vault. The adopted finite elements have quadratic interpolation, leading to a model with about 200.000 degrees of freedom. The actions considered include the self-weight of the structure, the weight of the infill, the seismic action and differential temperature. The elastic properties of the material were an elastic modulus of  $3000 \text{ N/mm}^2$  and a Poisson's ratio of 0.2.

Figure 20 presents the results in terms of deformed meshes and maximum (tensile) principal stresses for the combination of self-weight plus rubble infill. The maximum tensile stress found is lower than  $0.1 \text{ N/mm}^2$  and is located in the window-sills and ribs. These values are low and no cracking is thus expected in the structure. The vault is fully under compression for the self-weight and reaches a maximum tensile stress of  $0.15 \text{ N/mm}^2$  for the infill. The maximum compressive stress is lower than  $0.6 \text{ N/mm}^2$ , and is located in the columns, window corner, base of the buttresses and keys of the vault. In conclusion, the skylight should have minor or no damage under self-weight and infill, and the presence of the infill is unfavorable.

Seismic loading and temperature were then added to the structure, aiming at explaining the damage, see Figure 21. Even if the deformation for seismic loading has some resemblance with the observed movements in the structure for the West wall, the stresses found are too low to provoke any damage. The deformed mesh associated with the differential temperature indicates

that the walls move to the exterior and suffer significant bending, with significant curvatures in the columns. Still moderate stresses are found and the deformation is not in agreement with the observed movements, meaning that the temperature effect is relevant but should not be the main cause of the damage.

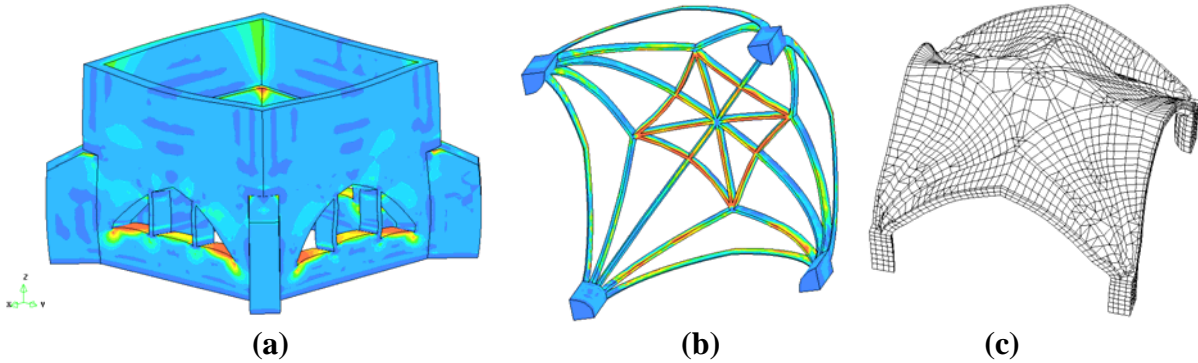

**Figure 20: Results for Self-Weight Plus Rubble Infill: (a) Maximum Principal Stresses in Walls; (b) Maximum Principal Stresses in Ribs; (c) Deformed Mesh for the Vault. The Red Color Indicates the Maximum Values, Which Are Below  $0.1 \text{ N/mm}^2$ .**

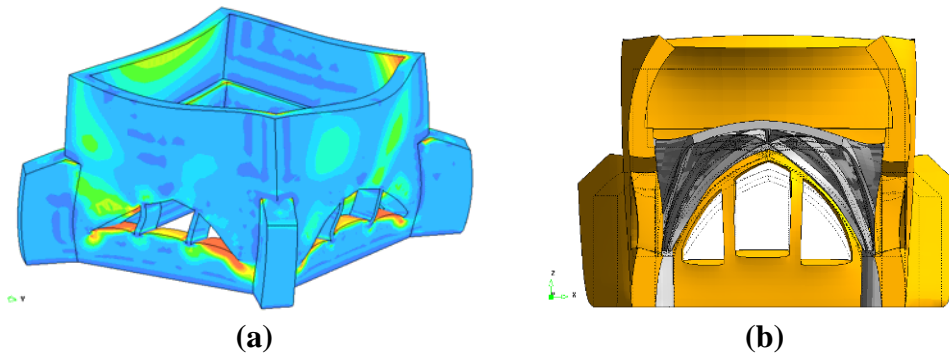

**Figure 21: Results with Live Loads: (a) Earthquake Combined with Other Loads; (b) Deformed Mesh Only for Differential Temperature.**

A full model of the church was then prepared to analyze the influence between the skylight, the adjacent structure and the soil, see Figure 22. The finite element model, even if over simplified, has about 50000 degrees of freedom and is made with plane shell elements, curved shell elements and beam elements. Interface elements were added to the supports in order to replicate the soil-structure interaction. The deformed mesh with the new analysis is shown in Figure 22 for the church and skylight. Very high tensile stresses are found in the skylight and the deformation is similar to the one observed in the structure, indicating that this is the major cause of damage.

Taking into consideration that the damage has progressed since the works carried out in the first half of the 20<sup>th</sup> century and that the main causes of damage are the soil-structure interaction and temperature, it was recommended to strengthen the structure. The remedial measures considered are the following: (a) injection of all cracks with a lime based grout; (b) addition of a steel ring that provides a stiff behavior to the skylight (possible further damage due to soil-structure interaction will occur in the buttresses connecting the skylight with the rest of the building. This damage does not compromise the stability of any part); (c) connection between the vault and the

West façade; (d) new timber roof (due to the very bad condition of the existing timber structure) and new gutter system; (e) lead water proof membrane in the walls to prevent water infiltration; (f) new window framing.

The details of the new steel structure are shown in Figure 23. It consists of a steel ring made of channel profiles that connects the internal and external part of the wall at the thirds of the span, and includes tensioning bars at 45° angle also at the thirds of the span. Details of the execution works are shown in Figure 24, namely with respect to the operation of cleaning the joints before injection, selecting an appropriate lime mortar composition with matching color and a view of the new steel and timber elements.

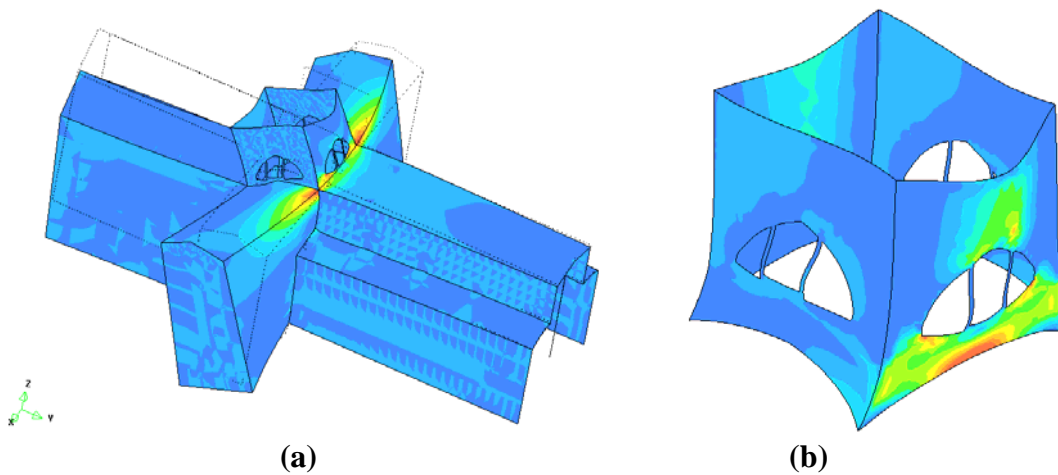

**Figure 22: Results for the Analysis of the Complete Church in Terms of Maximum Principal Stresses: (a) Full Model; (b) Detail of the Skylight. The Red Color Indicates the Maximum Values, Which Reach  $4.5 \text{ N/mm}^2$ .**

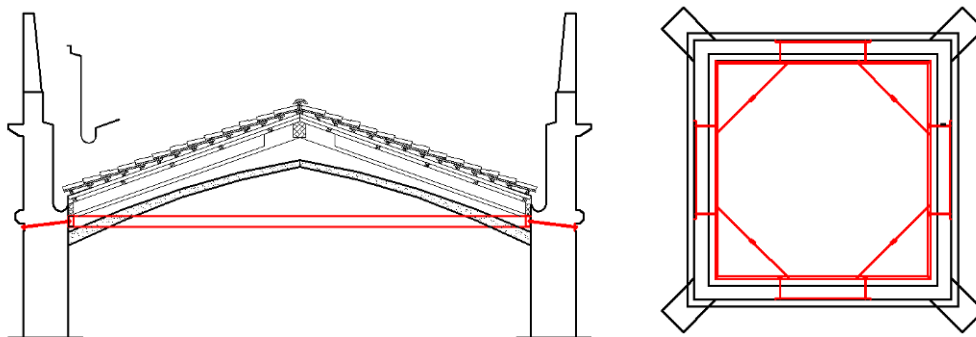
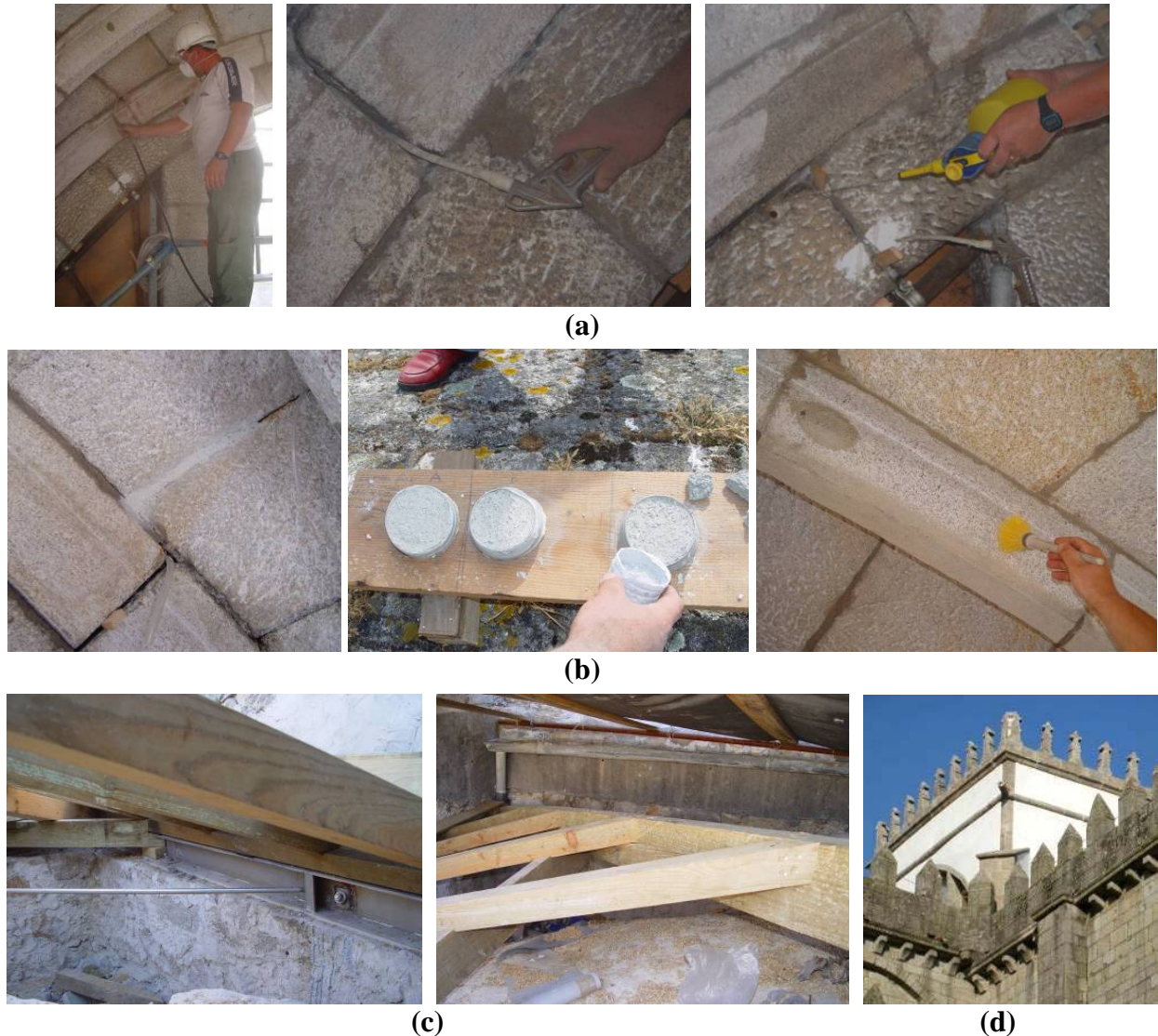

**Figure 23: Strengthening of the skylight: Cross section and plan.**

### **SALIENT ELEMENTS IN THE FAÇADE**

The central façade is composed of several salient elements, namely a central balcony and two lateral pinnacles, see Figure 25. The advanced degradation state of the granite and the fall of stone pieces led to an auxiliary protection structure to avoid injuring people. Due to the movements, cracks and a large number of cramps existing in the façade, an assessment of the stability conditions of the main salient structural elements of the façade was carried out. The elements considered are the balcony and the pinnacles.





**Figure 24: Aspects of the Works: (a) Air and Water Cleaning Before Injection; (b) Selection of Mortar Composition and Lime-Washing the Previous Cement Mortar Patches; (c) New Steel and Timber Structure; (d) Final View After Completing the Works.**

The balcony substructure consists of an almost semi-circular slab, made of granite ashlars that are bonded together with iron dowels. The slab is stiffened by three ribs of the same granite, a central one and two lateral. The loads considered in the balcony include the self weight and the granite balustrade of seven granite columns that also seems to integrate steel dowels, see Figure 25. The pinnacles are massive granite elements, supported in stone shells made of different stone elements. The stone presents severe signs of weathering, which probably results from combined action of cycles of wetting/drying, salt and pollution. Figure 26 shows examples of stone and iron damage, and biological activity.



**Figure 25: Salient Elements in the Façade: (a) General View; (b) Detail of the Balustrade.**



**Figure 26: Examples of Stone and Iron Deterioration.**

In order to check if the stone elements would be internally connected with iron dowels and also to verify if disassembling would be needed to prevent future damage due to iron expansion, a GPR inspection was performed, see Figure 27. In general, no iron elements were found inside the stone elements, even if many iron cramps are visible externally.



**Figure 27: Aspects of the GPR Inspection.**

Finally, a structural analysis of the salient elements was carried out using non-linear finite element analysis, see Figure 28. From the distribution of the maximum and minimum principal stresses it was found that low values of both tensile and compressive stresses are present. Still, a non-linear analysis was carried out, allowing to obtain a safety factor, with respect to the applied loads, between five and over sixty for the balcony and the pinnacles structure, respectively. Even if the tensile strength is significantly reduced, a safety factor over two and over ten is obtained for the same structures, with a clear failure mechanism. It is noted that the models assume a monolithic behavior of the elements, which is certainly not the case for the pinnacles structure. Therefore, some remedial measures have been proposed and are currently under execution.

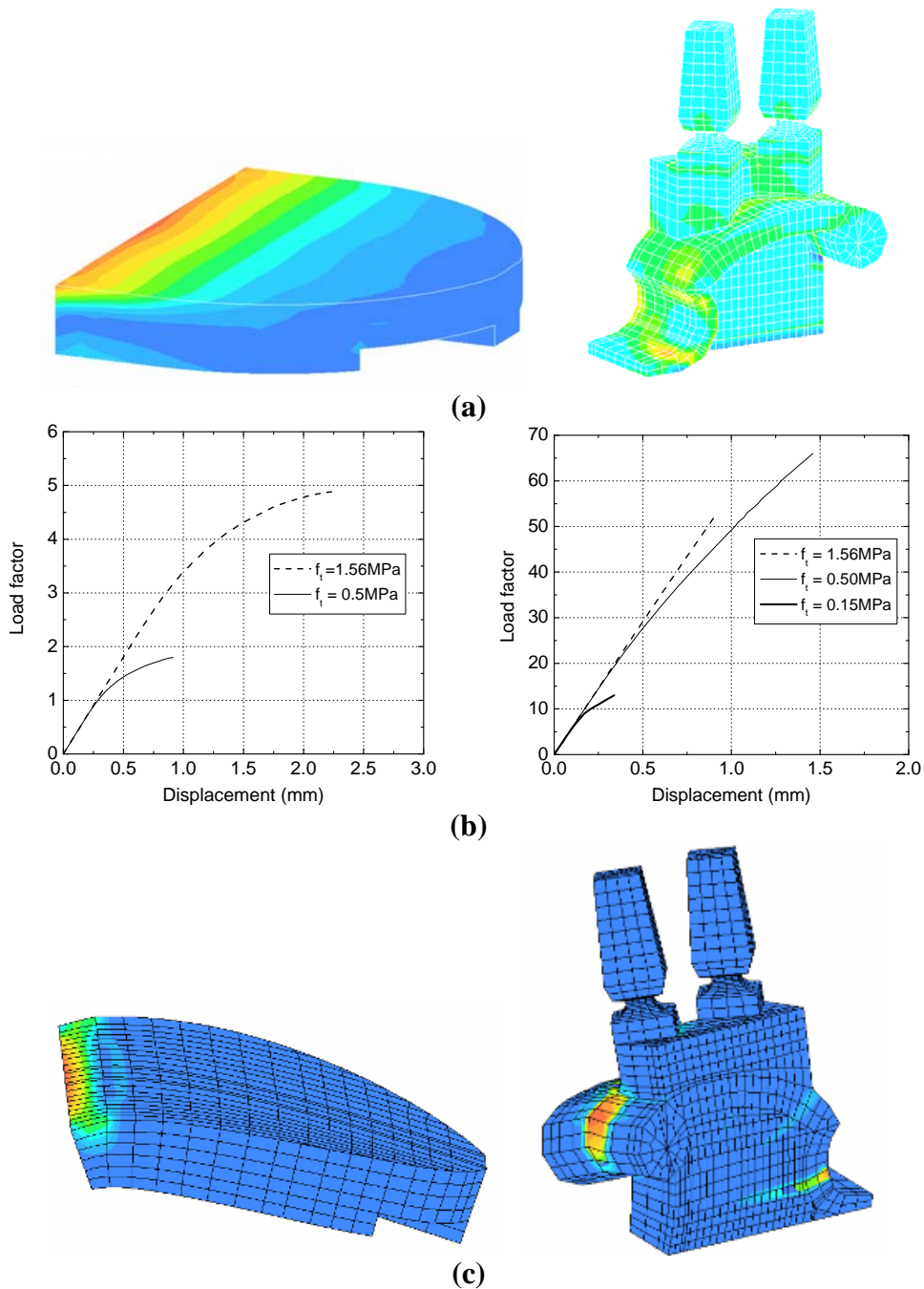

**Figure 28: Structural Analysis of Balcony and Pinnacles Structure: (a) Maximum Principal Stresses, with Highest Values in Red; (b) Force-Displacement Diagrams, Where the Load Factor Indicates the Magnification of the Self-weight and the Displacement is the Maximum Vertical Displacement; (c) Collapse Modes, with Highest Strains in Red.**

## CONCLUSIONS

The present paper addresses the works recently carried out at the Cathedral of Porto as a case study, with special focus to the structural aspects. Four aspects are treated in detail, namely the towers, the St. Vincent Chapel, the skylight and the salient elements in the façade.

The towers exhibit severe global damage including cracking, crushing and separation between leaves and also local damage in the cupolas, pinnacles and balustrades. The global damage seems mostly due to water infiltration, deficient conception of the structure, ancient damage due to lightning and changes in the structures of the towers. For the purpose of increasing the structural performance, a rigid frame of stainless steel profiles and a set of long, inclined anchors have been designed to provide a confining ring. In addition, new ties and stitching of the external leaves were also included when necessary.

The chapel exhibits a significant overload due to a rubble infill resulting from previous demolitions and the external wall presents moderate out-of-plane displacements. From the diagnostics, it was possible to safely prescribe the removal of the infill (approximately seven tons). This operation allowed to confirm that the present vault is not contemporary to the walls and the external wall deformation is stabilized.

The skylight presented cracking and separation between the walls and vaults, mostly due to temperature effects and soil-structure interaction. A rigid steel frame and a new timber roof have been added. The salient elements in the façade present severe stone deterioration and iron corrosion. The stability of the elements was demonstrated, even if some remedial measures have been adopted for an element exhibiting loose stone pieces and larger cracks.

## **ACKNOWLEDGEMENTS**

This work would not have been possible with the contribution of many others. The authors would like to acknowledge Ângela Melo and Mafalda Carneiro, architects from the Regional Directorate of Culture, responsible for the monument and daily coordination of the works, and without whom the successful completion of the works would not have been possible, Filipe Ferreira, chief engineer from the contractor, Pinho Borges, chief engineer for control and supervision of works, and Graça Vasconcelos and Francisco Fernandes from University of Minho, for their work in the inspection of the façade.

## **REFERENCES**

1. Lourenço, P.B., Melo, A., Carneiro, M. (2004) "Remedial measures for Cathedral of Porto: A post-modern conservation approach", in Structural analysis of historical constructions IV, Eds. C. Modena, P. Lourenço and P. Roca, A.A. Balkema Publishers, Leiden, 51-62.
2. Ljung, L. (1999) "System identification: Theory for the user", Second edition, Prentice Hall, Upper Saddle River, NJ, USA.
3. Ramos, L., Lourenço, P.B. (2007) "Report on the static monitoring of the South tower in the Cathedral of Porto: Final report", Report 07-DEC/E-32, University of Minho, 28p (in Portuguese).
4. Orduña, A., Lourenço, P.B. (2003) "Non-linear cap model for limit analysis of masonry structures", J. Struct. Engrg., ASCE 129(10), 1287-1430.
5. Lourenço, P.B., Krakowiak, K.J. (2004) "Diagnosis and stability analysis of the skylight in the Cathedral of Porto", Report 04-DEC/E-21, University of Minho, 27 pp + Annex (in Portuguese).
6. Vasconcelos, G., Lourenço, P.B., Fernandes, F. (2006) "Assessment of the stability of the hanging elements in the façade of the Cathedral of Porto", Report 06-DEC/E-012, University of Minho, 21 pp (in Portuguese).